

# Turmdrehkran 63 LC

Tower Crane / Grue à tour / Gru a torre  
Grúa torre / Guindaste de torre

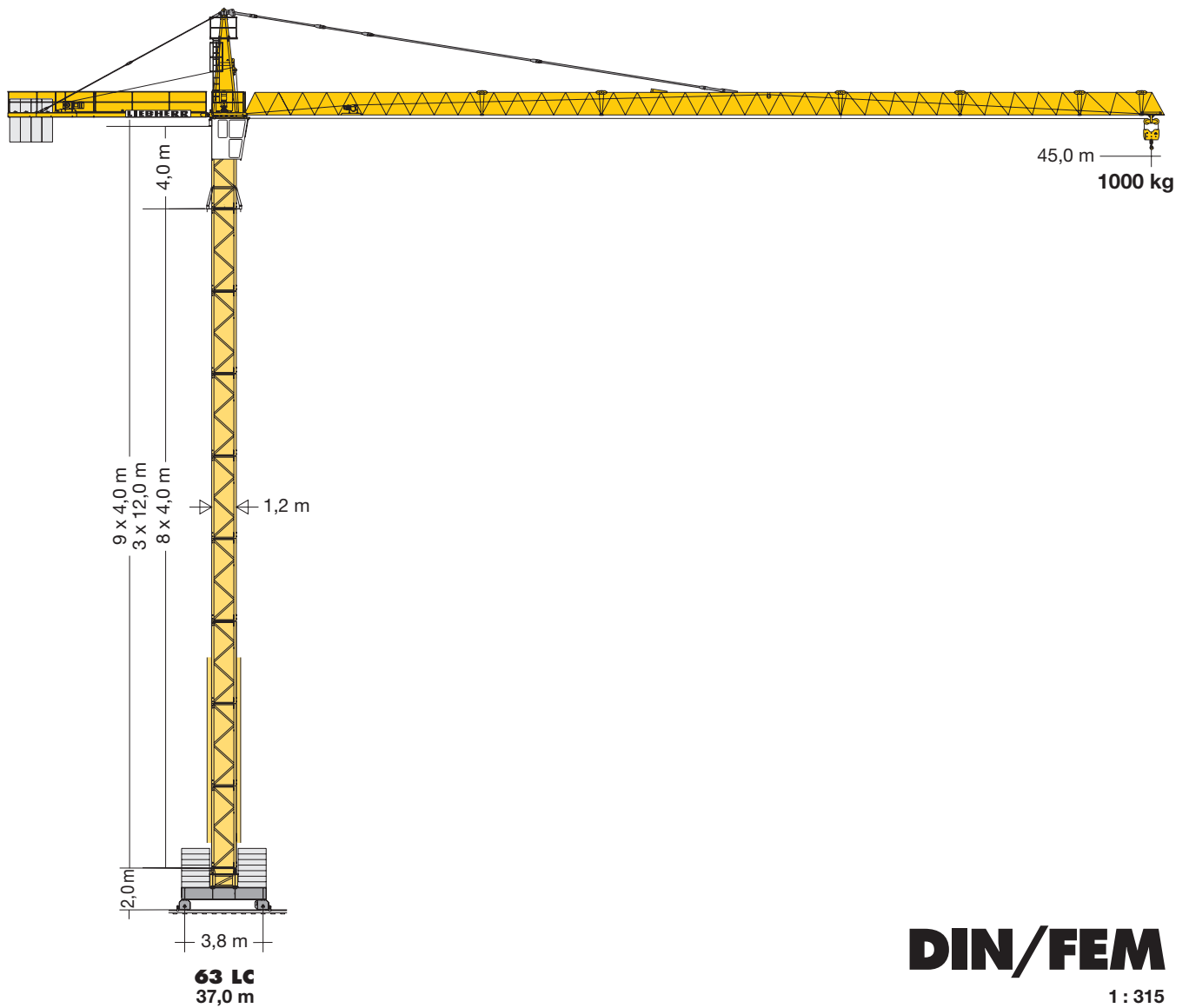

# LIEBHERR

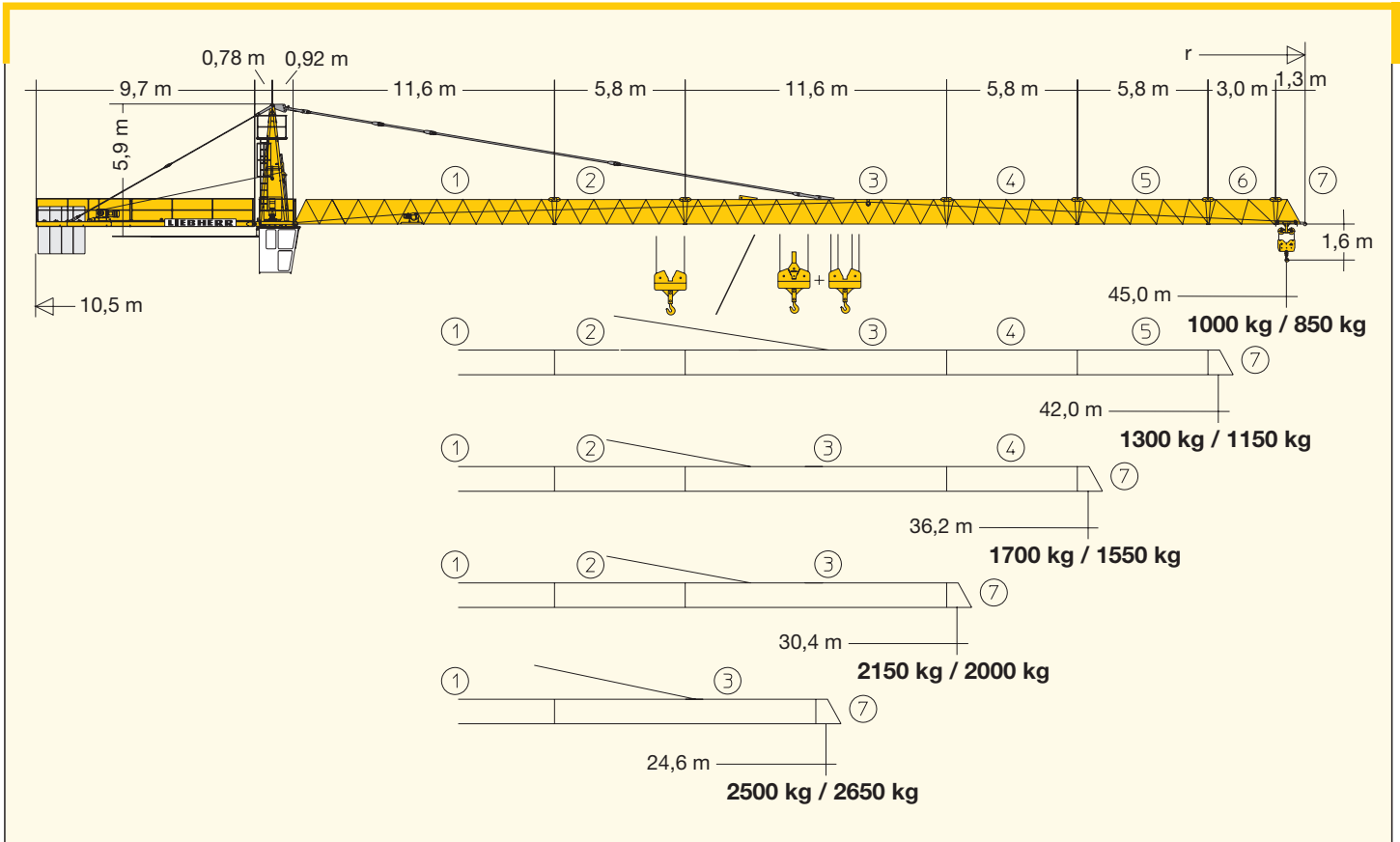

## Gewicht

Weight / Poids / Peso / Peso / Pesos

<b>Zentralballast / Central ballast</b> Lest de base / Zavorra centrale Lastro central / Lastre central	FEM: 40000 kg DIN: 50000 kg		(Ausl. 45 m)	9000 kg		19400 kg
---	--------------------------------	---	--------------	---------	---	----------

## Hubhöhe

Hoisting height / Hauteur sous crochet / Altezza di sollevamento / Altura bajo gancho / Altura de montagem

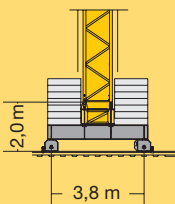
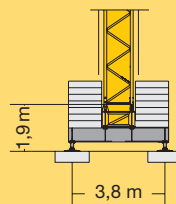
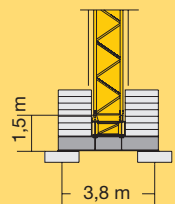
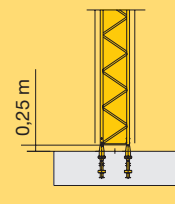
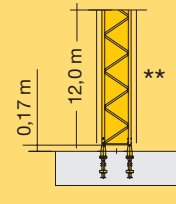
		63 LC				
4 m	12 m					
9*	3	37,0	36,9	36,5	35,3	47,1*
8		33,0	32,9	32,5	31,3	43,1*
7		29,0	28,9	28,5	27,3	39,1
6	2	25,0	24,9	24,5	23,3	35,1
5		21,0	20,9	20,5	19,3	31,1
4		17,0	16,9	16,5	15,3	27,1
3	1	13,0	12,9	12,5	11,3	23,1
2		9,0	8,9	8,5	7,3	19,1
1		5,0	4,9	4,5	3,3	15,1
0						11,1
		m	m	m	m	m
						



**Weitere Hubhöhen auf Anfrage.** / Further hoist heights on request. / Hauteurs sous crochet sur demande. / Altre altezze di sollevamento: su richiesta. / Outras alturas de elevação: conforme ao pedido. / Para alturas bajo gancho superiores, consultar.

\*\* nicht kletterbar / not for climbing / non télescopable / non telescopabile / no trepable / no telescopabel





# Ausladung und Tragfähigkeit





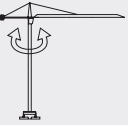
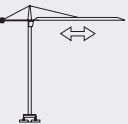





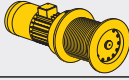
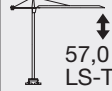





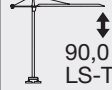





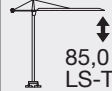





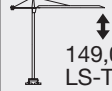





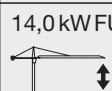





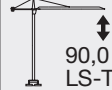







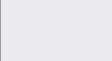



Radius and capacity / Portée et charge / Sbraccio e portata / Alcances y cargas / Alcance e capacidade de carga

m	r	m/kg	m/kg														
			12,0	14,0	16,0	18,0	20,0	22,0	24,6	28,0	30,4	34,0	36,2	40,0	42,0	45,0	
45,0	(r = 45,9)	2,1-20,6 2500					2500	2330	2050	1770	1610	1410	1310	1160	1090	1000	
42,0	(r = 42,9)	2,1-23,8 2500					2500	2500	2410	2080	1900	1670	1550	1380	1300		
36,2	(r = 37,1)	2,1-25,7 2500					2500	2500	2500	2280	2080	1830	1700				
30,4	(r = 31,3)	2,1-26,6 2500					2500	2500	2500	2360	2150						
24,6	(r = 25,5)	2,1-24,6 2500					2500	2500	2500								
m	r	m/kg	m/kg														
45,0	(r = 45,9)	2,1-19,8 2500	2,1-10,9 5000	4480	3760	3220	2800	2470	2200	1920	1630	1470	1260	1160	1010	940	850
42,0	(r = 42,9)	2,1-22,8 2500	2,1-12,5 5000	5000	4400	3780	3300	2920	2610	2280	1950	1760	1520	1400	1230	1150	
36,2	(r = 37,1)	2,1-24,5 2500	2,1-13,5 5000	5000	4790	4110	3600	3180	2850	2500	2140	1930	1680	1550			
30,4	(r = 31,3)	2,1-25,3 2500	2,1-13,8 5000	5000	4940	4250	3710	3290	2940	2580	2210	2000					
24,6	(r = 25,5)	2,1-24,6 2500	2,1-14,2 5000	5000	5000	4360	3810	3370	3020	2650							

# Antriebe

Driving units / Mécanismes d'entraînement / Azionamenti / Mecanismos / Mecanismos

	U/min 0 – 0,8 sl./min tr./min	5,0 kW EDC
	19,0 / 38,0 m/min 21,0 / 42,0 m/min	1,0 / 1,8 kW  1,5 / 3,0 kW 
	20,0 m/min	2 x 2,2 kW
	<b>kVA</b>	14,0 kW 14,0 kW FU 22,0 kW 26,0 26,0 35,0

		Stufe / Step Cran / Marcia Marcha / Marcha	kg	m/min
	3,2 / 14,0 / 14,0 kW 57,0 m LS-Trommel	4 <b>Lagen</b> Layers Couches Strati Camadas Capas	1  2500 	2500 6,2
			2  2500 	2500 27,0
			3  1300 	1200 54,0
	90,0 m LS-Trommel	6 <b>Lagen</b> Layers Couches Strati Camadas Capas	1  2400 	2300 6,5
			2  2400 	2300 28,5
			3  1200 	1100 57,0
	85,0 m LS-Trommel	3 <b>Lagen</b> Layers Couches Strati Camadas Capas	1  2500 	2500 6,0
			2  2500 	2500 27,0
			3  1800 	1700 56,0
	149,0 m LS-Trommel	5 <b>Lagen</b> Layers Couches Strati Camadas Capas	1  2500 	2500 6,2
			2  2500 	2500 28,0
			3  1700 	1600 58,0
	57,0 m LS-Trommel	4 <b>Lagen</b> Layers Couches Strati Camadas Capas	1  2500 	2500 5,0
			2  2500 	2500 25,0
			3  1900 	1800 36,0
	90,0 m LS-Trommel	6 <b>Lagen</b> Layers Couches Strati Camadas Capas	4  1300 	1200 52,0
			1  5000 	5000 2,5
			2  5000 	5000 12,5
			3  3800 	3800 18,0
	90,0 m LS-Trommel	6 <b>Lagen</b> Layers Couches Strati Camadas Capas	4  1200 	1100 54,0
			1  2500 	2500 5,2
			2  2500 	2500 26,0
			3  1750 	1650 37,0
	90,0 m LS-Trommel	6 <b>Lagen</b> Layers Couches Strati Camadas Capas	4  1200 	1100 54,0
			1  5000 	5000 2,6
	90,0 m LS-Trommel	6 <b>Lagen</b> Layers Couches Strati Camadas Capas	2  5000	5000 13,0
			3  3500	3500 18,5
	90,0 m LS-Trommel	6 <b>Lagen</b> Layers Couches Strati Camadas Capas	4  2350	2350 27,0
			1  5000	5000 2,6

Montagegewichte: siehe Betriebsanleitung. / Erection weights: see instruction manual. / Poids de montage: voir manuel de service. / Pesos di montaggio: vedasi le istruzioni sull'uso. / Pesos de montagem: vejãem-se as instruções p. uso. / Peso para el montaje: según manual.

<b>Kranoberteil</b>		Upper part of crane / Partie supérieure de grue / Parte superiore della gru Parte superior grúa / Parte superior do guindaste	L (m)	B (m)	H (m)	kg*		
Pos. Item Rep. Voce Pos. Ref.	Anz. Qty. Qta. Cant. Cant.	<b>Kabine + Steuerstand / Cabin + Seat</b> Cabine + fauteuil / Cabina + poltrona Cabine + cadeira / Cabina + butaca			1,87	1,12	2,18	440
2	1	<b>Turmspitze mit Kud-Auflage</b> Tower head section with slewing ring support Porte-fèche avec pivot / Testa porta-braccio con supporto ralla Cabeça de apoio de lança / Cabeza de torre con asiento de pista			5,57	1,86	1,73	2530
3	1	<b>Gegenausleger / Counter-jib</b> Contre-fèche / Contrabaccio Contra-lança / Contrapluma			9,79	1,46	0,36	960
4	1	<b>Ausleger-Anlenkstück / Jib heel section</b> Pied de fèche / Settore articolato di braccio Base articulada de lança / Pluma tramo primero			11,85	1,04	1,30	① 1070
5	1	<b>Ausleger-Zwischenstück / Intermediate jib section</b> Élément intermédiaire de fèche / Spezzone di braccio Peça suplementar da lança / Tramo intermedio pluma			5,94 11,80 5,94 5,94 3,18	0,95 0,95 0,95 0,95 0,95	1,22 1,32 1,22 1,22 1,22	② 401 ③ 810 ④ 261 ⑤ 210 ⑥ 111
6	1	<b>Ausleger-Kopfstück / Jib head</b> Pointe de fèche / Punta freccia Cabeça de lança / Tramo punta de pluma			1,45	1,04	1,37	⑦ 80
7	1	<b>Podeste / Platforms</b> Plates-formes / Plattaforma Plataforma / Plataforma			1,90	0,35	1,60	160
8	1	<b>Laufkatze / Trolley</b> Chariot / Carrello Carrinho / Carrito			0,95	1,13	0,62	151
9	1	<b>Unterflasche / Bottom</b> Moufle / Bozzello Gancha / Potipasto			0,75	0,24	0,98	104
10	1	<b>Hubwerk 14 kW / Winch</b> Treuil / Argano / Mecanismo elevatória Mecanismo elevación carga			1,25	1,23	0,55	450
<b>Turm</b>		<b>Tower / Mât / Torre</b> Torre / Torre						
11	1	<b>Turmstück / Tower section</b> Élément de mât / Elemento di torre Torre / Torre			12,0 m 4,0 m	12,27 4,27	1,20 1,20 1,30	2435 958
12	1	<b>Grundturmstück / Base tower section</b> Mât de base / Elemento di torre base Tramo torre base / Peça de base de torre			12,00	1,42	1,42	3343
<b>Klettereinrichtung</b>		<b>Climbing equipment / Equipement de télescopage / Attrezzatura per allungamento della gru</b> Equipo de trepado / Acessórios p. subida no edificio						
13	1	<b>Führungsstück kpl. / Guide section cpl.</b> Cage télescopique cpl. / Gabbia de sopraelevazione compl. Peça de guia compl. / Torre de montagem completa			8,92	1,65	1,75	1890
14	1	<b>Führungsstück Turmstück / Tower guide section</b> Élément de mât télescopique / Gabbia de sopraelevazione Peca de guia / Tramo torre de montaje			4,27	1,66	1,66	1120
15	1	<b>Hydraulikanlage, Stütz- und Klettertraverse / Hydraulic unit, supporting and climbing cross members</b> Système hydraul. avec traverses d'appui et de télescop. / Sist. idraul., traversa di appoggio e allugam. gru Instalação hidráulica, travessa de apoio e subida / Sistema hidráulico con traviesa de apoyo y trepade			4,86	0,95	0,70	580
<b>Unterwagen</b>		<b>Undercarriage / Châssis / Carro della gru</b> Carro con mástil / Carro de guindaste						
16	1	<b>Unterwagen-Rahmen / Undercarriage frame</b> Cadre de châssis / Intelaiatura carro Estrutura do carrinho / Bastidor carretón			4,12	0,94	1,39	2575
17	2	<b>Tragholm / Arm</b> Longeron / Longherone Travessa / Brazo			4,10	0,30	0,60	935
18	2	<b>Fahrschemel mit Antrieb / Rail bogie with drive</b> Bogie moteur / Telajo con gruppa propulsore Quadra sem grupa de propulsão / Caja rodillo motriz			0,78	0,84	0,53	297
19	2	<b>Fahrschemel ohne Antrieb / Rail bogie without drive</b> Bogie fou / Telajo senza gruppa propulsore Quadra com grupa de propulsão / Caja rodillo conducido			0,66	0,30	0,51	204
20	1	<b>Seile und Kleinteile / Small parts and ropes</b> Accessoire et câbles / Accessori cavi Acessorios e cabos / Accesorios y cables			-	-	-	1300

\* Einzelgewichte. / Single weights. / Poids individuels. / Pesos di componenti. / Pesos de peças componentes. / Pesos unitarios.

### Konstruktionsänderungen vorbehalten!

Subject to alterations! / Sous réserves de modifications!  
Si fa riserva di modifiche! / Salvo modificação da construoão!  
¡Sujeto a modificaciones!

### Sämtliche Angaben erfolgen ohne Gewähr. / This information is supplied without liability.

Ces renseignements sont sans garantie. / Le indicazioni contenute si intendono salvo errori ed omissioni.  
Declinamos toda responsabilidad derivada de la información proporcionada. / Declinamos qualquer  
responsabilidade quanto à informação fornecida.